

Translation of the Original operating instructions

EKF 300, 450, 452



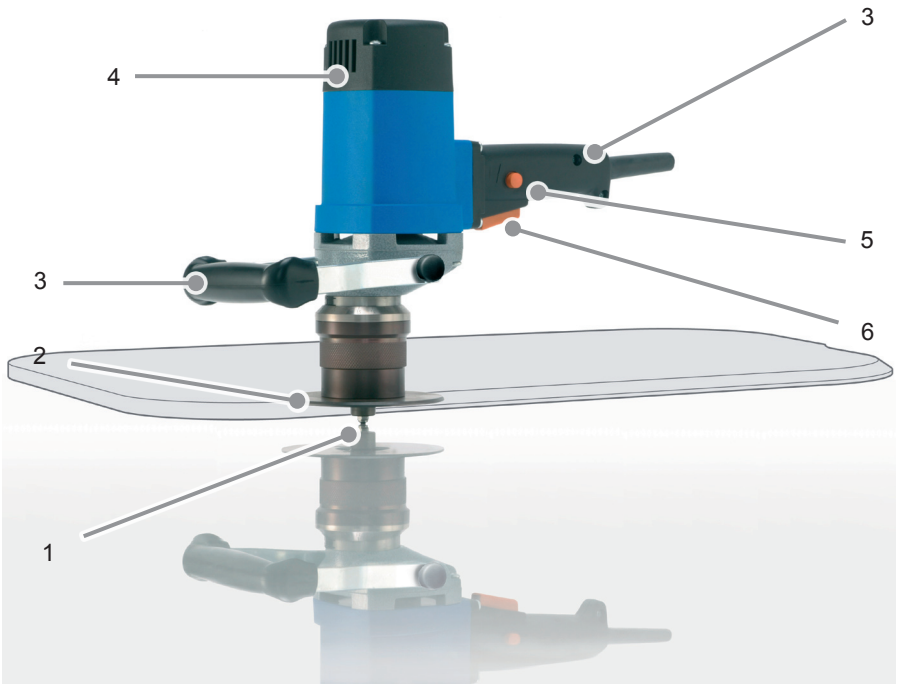

Table of Contents

General instructions 3
Safety 5
Components / delivery contents 8
Before using for the first time 9
Setting up 9
Use 10
Tool change 11
Cleaning 12
Maintenance 12
Storage 12
Troubleshooting 13
Technical data 14

Dear Customer,
 Before using the machine, please read the operating instructions contained in these operating instructions on startup, safety, intended use as well as cleaning and care.
 The links and illustrations in these instructions refer to the illustrations on the inside of the cover.
 Keep these operating instructions for later use and pass them onto the next owner of the machine.

General instructions

Copyright

This document is copyrighted. Any duplication or reprinting, in whole or in part, and the reproduction of the illustrations, even in modified form, is only permitted with the written approval of the manufacturer.

Liability disclaimer

All technical information, data and instructions for commissioning, operation and maintenance of the machine contained in these operating instructions represent the latest status at the time of printing.

The manufacturer assumes no liability for damage or injury resulting from failure to observe the operating instructions, use for other than the intended purpose, unprofessional repairs, unauthorised modifications or use of non-approved spare parts and accessories, tools and lubricants.

Declaration of Conformity

BDS Maschinen GmbH hereby declares that this device complies with the fundamental requirements and other relevant provisions of 2004/108/EC and 2006/42/EC directives.

A comprehensive Declaration of Conformity is available on request

Instructions on disposal



The packaging materials used can be recycled. When no longer required, dispose of the packaging materials according to local environmental regulations.



This product may not be disposed of in the domestic refuse within the European Union. Dispose of the device via communal collection points.

Safety warning structure

The following warnings are used in these operating instructions:

DANGER

A warning of this category indicates an impending dangerous situation.

If the dangerous situation is not avoided, it may lead to serious injury or even death.

- ▶ Follow the instructions in this warning to avoid possible danger of serious injury or even death.

WARNING

A warning of this category indicates a potentially dangerous situation.

If the dangerous situation is not avoided, it may lead to injuries.

- ▶ Follow the instructions in this warning to avoid possible danger of serious personal injuries.

CAUTION

A warning statement for this safety risk class indicates a damage risk.

If the situation is not avoided, it may lead to material damage.

- ▶ Follow the instructions in this warning to avoid material damage.

NOTE

- ▶ A note indicates additional information that simplifies the use of the machine.

Intended use

The machine is only intended for milling welded edges. The machine may only be operated in a horizontal position.

Any use other than previously stated is considered as improper use.

WARNING

Danger resulting from improper use!

If not used for its intended purpose and/ or used in any other way, the machine may be or become a source of danger.

- ▶ Use the machine only for its intended purpose.
- ▶ Observe the procedures described in these operating instructions.

No claims of any kind will be accepted for damage resulting from use of the appliance for other than its intended purpose.

The risk must be borne solely by the user.

NOTE

- ▶ If used commercially, pay attention to compliance with the accident prevention and occupational safety regulations.

Safety

CAUTION

When using electrical tools, the following fundamental precautions must be taken to protect against electric shock and the risk of injury and fire!

Fundamental safety precautions

- Do not use the machine in flammable or potentially explosive environments.
- Persons who are unable to operate the machine due to their physical, mental or motor response abilities may only use the machine under supervision of or instruction by a responsible person.
- Children must not be allowed to use the machine.
- Inspect the machine for visible signs of damage before use. Do not use a damaged machine.
- Before beginning work, check the function of the switches on the machine.
- Repairs to the mains cable may only be carried out by a qualified electrician.
- Repairs to the machine may only be carried out by an authorised specialist workshop or by the works customer service. Improper repairs can cause considerable danger to the user.
- Repairs to the machine during the warranty period may only be carried out by a service centre authorised by the manufacturer otherwise the guarantee will be invalidated..
- Defective parts may only be replaced with original spare parts. Only original spare parts guarantee that the safety requirements are met.
- Do not leave the machine unsupervised during operation.
- Store the machine in a dry, temperate location out of the reach of children.
- Do not leave the machine standing outdoors and do not expose it to moisture.
- Make sure that your work area is sufficiently lit (>300 Lux).
- Do not use low-power machines for heavy working.
- Make sure that your workplace is clean.
- Keep the machine clean, dry and free of oil and grease.

Danger of electric current!

DANGER

Danger to life from electric current!
Contact with live wires or components can lead to serious injury or even death!

Observe the following safety precautions to avoid any danger from electric current:

- ▶ Do not open the housing of the machine. Risk of electric shock if live terminals are touched.
- ▶ Never immerse the machine or the plug into water or other liquids.
- ▶ Only use extension Only use extension or cable drums with a cable cross-section of 1.5 mm².
- ▶ Only use extension Only use extension that are approved for the place of work.
- ▶ Check the condition of the extension cable regularly and replace if damaged.
- ▶ Avoid direct body contact with grounded parts (e.g., tubes, radiators, steel girders) to reduce the risk of electric shock in the event of a defect.

Risk of injury

WARNING

Improper handling of the machine increases the risk of injury!

Observe the following safety precautions to avoid injuring yourself and/or others:

- ▶ Operate the machine only with the protective equipment stipulated in these operating instructions (see **Personal protective equipment** section).
- ▶ Remove loose jewellery before beginning work. Wear a hair net if you have long hair.
- ▶ Always switch off the machine before changing tools, performing maintenance or cleaning. Wait until the machine has come to a complete standstill.
- ▶ Always remove the plug from the mains socket before changing tools, cleaning or performing maintenance work in order to avoid unintentional starting of the machine.
- ▶ Do not put your hand into the machine while it is in operation. Remove swarf only when the machine is at a standstill.
- ▶ Check that the tool is tightened securely before using (see **Inserting the tool** section).
- ▶ Do not allow the connecting cable to hang over edges (trip wire effect).

Preventing damage

CAUTION

Potential damage to property if the machine is improperly used!

Observe the following instructions to avoid property to damage:

- ▶ Before connecting the machine, compare the connection data (voltage and frequency) on the rating plate with those of your mains power supply. The data must correspond in order to avoid damage to the machine.
- ▶ Always use the handle to carry the machine and not the connecting cable.
- ▶ Do not pull the mains cable to remove the plug from the mains socket.
- ▶ Do not crush the connecting cable.
- ▶ Do not expose the connecting cable to heat or chemical liquids.
- ▶ Do not pull the connecting cable across sharp edges or hot surfaces.
- ▶ Lay the connecting cable in such a way that it cannot be caught and wound up in the rotating part of the machine.

Safety appliances

Overload protection



A motor protection switch protects the milling motor against overloading.

Swarf guard

The machine is equipped with swarf protection that largely prevents swarf from spinning out. The swarf falls out underneath the machine during milling.

Symbols on the machine

The symbols on the machine have the following meaning:

| Symbol | Meaning |
|--|--|
|  | Electric shock hazard! |
|  | Read the operating instructions before beginning work! |
|  | Wear protective goggles and ear protection! |
|  | Wear protective gloves |

Personal protective equipment

Wear the following protective equipment at all times when operating the machine:

| Symbol | Meaning |
|--------|---|
| | Close-fitting work protection clothing with a low tear strength |
| | Goggles to protect the eyes against flying objects |
| | Safety shoes for protecting feet against falling objects. |

Also wear the following protective equipment during special work:

| Symbol | Meaning |
|--------|---|
| | Ear protection in areas with high noise emission > 80 dB(A) |
| | Gloves for protection against injuries |

Components / delivery contents

Machine overview

| | |
|---|-------------------|
| 1 | Milling cutter |
| 2 | Supporting plate |
| 3 | Handles |
| 4 | Drive motor |
| 5 | Locking mechanism |
| 6 | ON/OFF switch |
| 7 | Clamping screw |

Scope of supply

| | |
|----|--|
| 20 | Machine |
| 21 | Transport case |
| 22 | Milling cutter |
| 23 | SW 22 open-end wrench |
| 24 | Hook wrench |
| | Hard metal reversing plates (3x) (not illustrated) |
| | Torx screwdriver, T9 (not illustrated) |
| | Operating instructions/guarantee card (not illustrated) |

Before using for the first time

Transport inspection

As standard, the machine is supplied with the components indicated in the **Components/delivery contents** section.

NOTE

- ▶ Check for visible signs of damage or missing items on delivery. Report an incomplete or damaged delivery to your supplier/retailer immediately.

Setting up

This section contains important instructions on required preparation before starting setup work.

Safety measures

⚠ WARNING

Risk of injury from a falling machine.

Observe the following safety instructions to avoid any danger.

- ▶ The machine may only be operated in a horizontal position.
- ▶ Secure the workpiece.

Checking the properties of the workpiece

The surface of the workpiece must meet the following requirements:

- The surface must be smooth and may not have any burn points, slag, welding joints or similar.

NOTE

- ▶ Before beginning with milling, remove surface unevenness.

Setting the chamfer height

- ◆ Loosen the side clamping screw.
- ◆ Set the desired chamfer height by turning the entire machine head. The set value can be read from the ring scale.
- ◆ Tighten the clamping screw again.

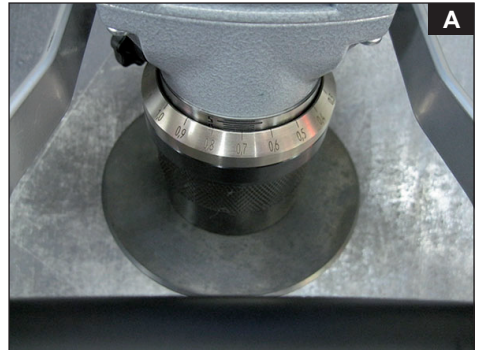

Use

Switching on the machine

- ◆ To switch on the machine, press and hold down the ON/OFF switch (6).
- ◆ Lock the ON/OFF switch in the switched-on position by pressing the locking mechanism (5).

Switching off the machine

- ◆ To switch off the machine, press the ON/OFF switch. The locking mechanism is released automatically.

Milling with the machine

For milling, proceed as follows:

- ◆ Align the workpiece to be processed horizontally and secure it.

CAUTION

Potential damage to property if the machine is improperly used!

Observe the following instructions to avoid property to damage:

- ▶ Lay the connecting cable so that it cannot be caught by the running machine.
- ◆ Set the chamfer height, see section **Setting the chamfer height**.
- ◆ Insert the plug into the mains socket.
- ◆ Clasp both handles and put the machine upright with the supporting plate onto the workpiece so that the milling milling cutter does not move onto the workpiece.

- ◆ Switch the machine on, see section **Switching on the machine**.
- ◆ Wait until the maximum speed is reached. This process takes approx. 3 seconds.

NOTE

Observe the following instructions:

- ▶ Never attach the reversing plates to the material during standstill.
- ▶ Maintain an even feed.
- ◆ Push the machine slowly and evenly in the opposite running direction of the tool.

NOTE

Observe the following instructions:

- ▶ Pay attention to the direction of rotation marking on the supporting plate.
- ▶ Makes sure that the machine and the supporting plate rest on each other evenly.
- ◆ Before switching off, remove the machine from the tool.
- ◆ Switch off the machine, see section **Switching off the machine**.
- ◆ Pull the plug out of the mains socket.

Tool change

⚠ WARNING

Risk of injury!

- ▶ Do not use damaged, contaminated or worn tools.
- ▶ Change tools only when the machine is switched off and at a standstill. Pull the plug out of the mains socket.
- ▶ Only use tools, adapter and accessories that match the machine.

Replacing the milling cutter

- ◆ Loosen the side clamping screw.
- ◆ Unscrew the housing from the motor.
- ◆ Loosen and remove the milling cutter with the tool supplied (SW 22 open-end wrench, hook wrench).
- ◆ Screw in the desired milling cutter.
- ◆ Screw on the housing again.
- ◆ Tight the clamping screw.

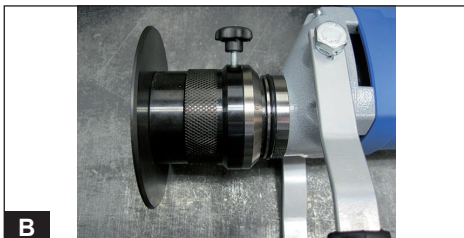

Turning the reversing plate

- ◆ Loosen the side clamping screw.
- ◆ Unscrew the housing from the motor.
- ◆ Loosen the fixing screw with the Torx pin wrench, turn the reversing plate and tighten fixing screw again.
- ◆ Repeat the procedure for all reversing plates of the miller.
- ◆ Screw on the housing again.
- ◆ Tight the clamping screw.

Replacing the reversing plate

When the reversing plate is completely worn, it must be replaced by a new one:

- ◆ Unscrew the fixing screw with the Torx pin wrench and remove the reversing plate.
- ◆ Insert the reversing plate and tighten the fastening screws again.

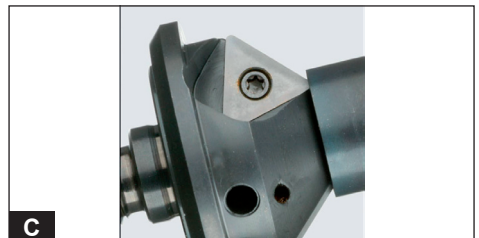

Cleaning

WARNING

- ▶ Switch off the machine and pull the plug out of the mains socket before starting maintenance and cleaning.
- ▶ When using compressed air for cleaning, wear protective goggles and gloves and protect other persons in the working area.

CAUTION

- ▶ Never immerse the machine in water or other liquids.

After every use

- ◆ Remove swarf on the machine.
- ◆ Clean the tool on the underneath of the machine.
- ◆ Put the machine and accessories into the transport case.

Maintenance

WARNING

Danger caused by unqualified repairs!

Unqualified repairs can lead to considerable danger for the user and cause damage to the machine.

- ▶ Repairs to electrical appliances may only be carried out by the works customer service or by specialists trained by the manufacturer.
- ◆ Check the milling cutter and the reversing plates regularly for wear.

Customer service/service

Should you have any questions on customer service/service, please contact BDS. We will be happy to give you the address of your nearest service partner.

Storage

If you do not intend to use the machine for a longer period of time, clean it as described in the section **Cleaning**. Store the machine and all its accessories in the transport case at a dry, clean and frost-free location.

Troubleshooting

| Fault | Possible cause | Remedy |
|---|--|---|
| The motor does not start after pressing the ON/OFF switch. | Plug not inserted into socket. | Insert plug. |
| | Automatic circuit breaker tripped. | Switch on the automatic circuit breaker again. |
| The automatic circuit breaker in the electrical distribution board trips. | Too many appliances connected to the same power circuit. | Reduce the number of appliances on the power circuit. |
| | The machine is defective. | Contact customer service. |

NOTE

- ▶ If you cannot resolve the problem with the steps described above, please contact customer service.

Technical data

| Model | EKF 300 | EKF 450 | EKF 452 | |
|---------------------------------------|--|-----------------|-------------------------|------------------|
| Dimensions (L x W x H) | 310 x 295 x 138 | 310 x 295 x 138 | 310 x 295 x 138 | mm |
| Approx. net weight. | 4.6 | 4.6 | 4.6 | kg |
| Operating voltage (see type plate) | 230 V / 50-60 Hz or 110/125 / 50-60 Hz | | | |
| Power consumption | 1500 | 1500 | 1500 | W |
| Noise emission | 90 | 90 | 90 | dB(A) |
| Vibration | 1.53 | 1.53 | 1.53 | m/s ² |
| Rotating speed | 6000 | 6000 | 6000 | rpm |
| Feed | manual | | | |
| Chamfer angle | 30° | 45° | Radius 2.5 mm | |
| Chamfer width | 0 - 5 | 0 - 6 | - | mm |
| Cutting tool | Screw-in milling cutter with 3 hard metal reversing plates | | | |
| Cutter type | ZFR 300.3 - 30° | ZFR 450.3 - 45° | ZFR 452.3 - R 2.5 mm | |
| Connecting cable length | 4 | 4 | 4 | m |
| Protection class | I | I | I | |

BDS Maschinen GmbH

Martinstraße 108
D-41063 Mönchengladbach

Fon: +49 (0) 2161 / 3546-0

Fax: +49 (0) 2161 / 3546-90

Internet: www.bds-maschinen.de

E-Mail: info@bds-maschinen.de
